

## Low voltage fast-switching NPN power transistor

### Features

- Very low collector to emitter saturation voltage
- High current gain characteristic
- Fast-switching speed
- Through-hole IPAK (TO-251) power package in tube (suffix "-1")
- Surface mounting DPAK (TO-252) power package in tape & reel (suffix "T4")

### Applications

- Ccfl drivers
- Voltage regulators
- Relay drivers
- High efficiency low voltage switching applications

### Description

The device is manufactured in NPN Planar Technology by using a "Base Island" layout. The resulting transistor shows exceptional high gain performance coupled with very low saturation voltage.

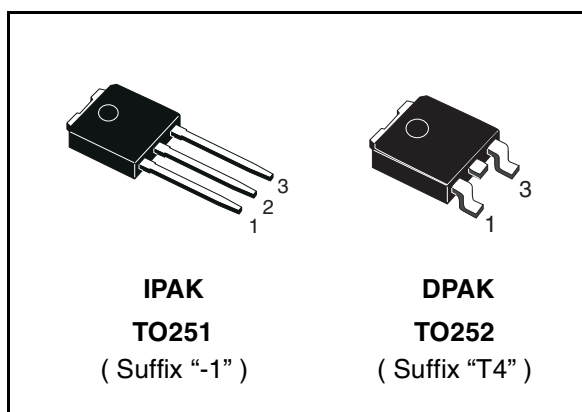


Figure 1. Internal schematic diagram

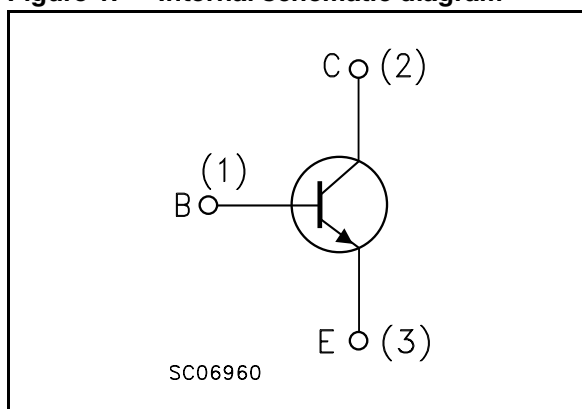


Table 1. Device summary

Order code	Marking	Package	Packing
2STD1665T4	D1665	DPAK	Tape & reel
2STD1665-1	D1665	IPAK	Tube

# Contents

- 1      Electrical ratings ..... 3**
  
- 2      Electrical characteristics ..... 4**
  - 2.1    Electrical characteristics (curves) ..... 5
  - 2.2    Test circuits ..... 7
  
- 3      Package mechanical data ..... 8**
  
- 4      Revision history ..... 11**



# 1 Electrical ratings

**Table 2. Absolute maximum rating**

Symbol	Parameter	Value	Unit
$V_{CBO}$	Collector-base voltage ( $I_E = 0$ )	150	V
$V_{CEO}$	Collector-emitter voltage ( $I_B = 0$ )	65	V
$V_{EBO}$	Emitter-base voltage ( $I_C = 0$ )	7	V
$I_C$	Collector current	6	A
$I_{CM}$	Collector peak current ( $t_P < 5\text{ms}$ )	20	A
$I_B$	Base current	1	A
$P_{tot}$	Total dissipation at $T_C = 25\text{ °C}$	15	W
$T_{stg}$	Storage temperature	-65 to 150	°C
$T_J$	Max. operating junction temperature	150	°C

**Table 3. Thermal data**

Symbol	Parameter	Value	Unit
$R_{thj-amb}$	Thermal resistance junction-case max	8.33	°C/W

## 2 Electrical characteristics

( $T_{\text{case}} = 25\text{ °C}$  unless otherwise specified)

**Table 4. Electrical characteristics**

Symbol	Parameter	Test conditions	Min.	Typ.	Max.	Unit
$I_{\text{CBO}}$	Collector cut-off current ( $I_{\text{E}} = 0$ )	$V_{\text{CB}} = 120\text{ V}$ $V_{\text{CB}} = 120\text{ V}$ $T_{\text{C}} = 100\text{ °C}$			50 1	nA $\mu\text{A}$
$I_{\text{EBO}}$	Emitter cut-off current ( $I_{\text{C}} = 0$ )	$V_{\text{EB}} = 7\text{ V}$			10	nA
$V_{(\text{BR})\text{CBO}}^{(1)}$	Collector-base breakdown voltage ( $I_{\text{E}} = 0$ )	$I_{\text{C}} = 100\text{ }\mu\text{A}$	150			V
$V_{(\text{BR})\text{CEO}}^{(1)}$	Collector-emitter breakdown voltage ( $I_{\text{B}} = 0$ )	$I_{\text{C}} = 10\text{ mA}$	65			V
$V_{(\text{BR})\text{EBO}}^{(1)}$	Emitter-base breakdown voltage ( $I_{\text{C}} = 0$ )	$I_{\text{E}} = 100\text{ }\mu\text{A}$	7			V
$V_{\text{CE}(\text{sat})}^{(1)}$	Collector-emitter saturation voltage	$I_{\text{C}} = 100\text{ mA}$ $I_{\text{B}} = 5\text{ mA}$ $I_{\text{C}} = 1\text{ A}$ $I_{\text{B}} = 50\text{ mA}$ $I_{\text{C}} = 2\text{ A}$ $I_{\text{B}} = 50\text{ mA}$ $I_{\text{C}} = 6\text{ A}$ $I_{\text{B}} = 150\text{ mA}$ $I_{\text{C}} = 6\text{ A}$ $I_{\text{B}} = 300\text{ mA}$		50 100 260 230	120 200 600 380	mV mV mV mV
$V_{\text{BE}(\text{sat})}^{(1)}$	Base-emitter saturation voltage	$I_{\text{C}} = 4\text{ A}$ $I_{\text{B}} = 200\text{ mA}$		1	1.15	V
$V_{\text{BE}(\text{on})}^{(1)}$	Base-emitter On voltage	$I_{\text{C}} = 4\text{ A}$ $V_{\text{CE}} = 1\text{ V}$		0.85	1	V
$h_{\text{FE}}$	DC current gain	$I_{\text{C}} = 10\text{ mA}$ $V_{\text{CE}} = 1\text{ V}$ $I_{\text{C}} = 2\text{ A}$ $V_{\text{CE}} = 1\text{ V}$ $I_{\text{C}} = 5\text{ A}$ $V_{\text{CE}} = 1\text{ V}$ $I_{\text{C}} = 10\text{ A}$ $V_{\text{CE}} = 1\text{ V}$	150 150 90 30	320 310 175 65	350	
$C_{\text{CBO}}$	Collector-base capacitance	$V_{\text{CB}} = 10\text{ V}$ $f = 1\text{ MHz}$		45		pF
$t_{\text{ON}}$ $t_{\text{s}}$ $t_{\text{f}}$	Resistive load Turn-on time Storage time Fall time	$I_{\text{C}} = 3\text{ A}$ $V_{\text{CC}} = 10\text{ V}$ $I_{\text{B}1} = -I_{\text{B}2} = 0.3\text{ A}$		90 800 90		ns ns ns

1. Pulsed duration = 300  $\mu\text{s}$ , duty cycle  $\leq 1.5\%$ .

## 2.1 Electrical characteristics (curves)

Figure 2. Output characteristics

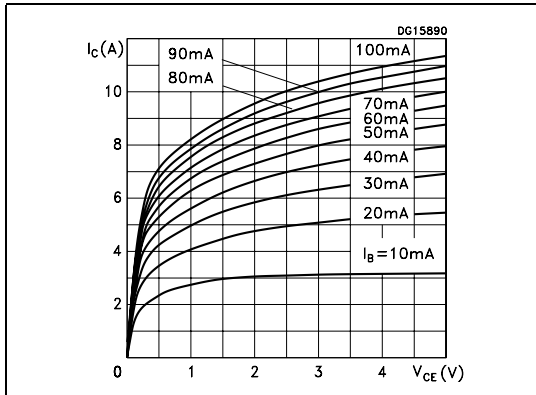


Figure 3. DC current gain

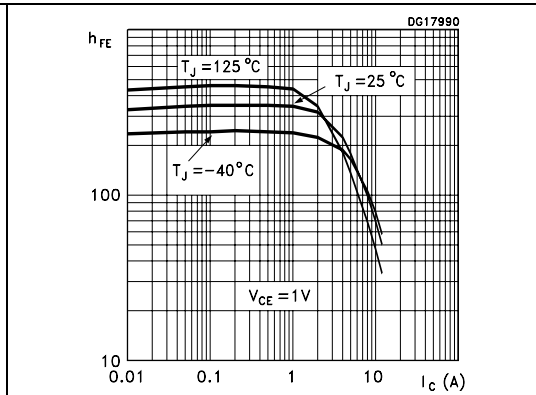


Figure 4. Collector-emitter saturation voltage

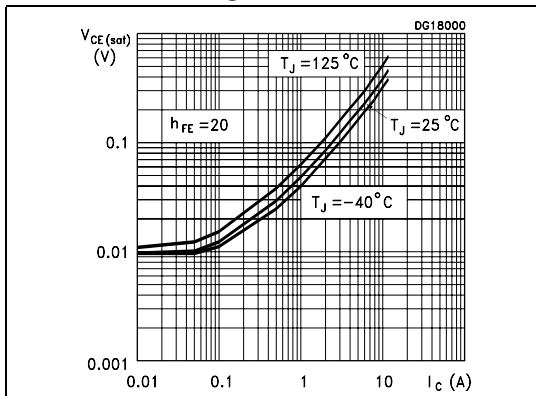


Figure 5. Collector-emitter saturation voltage

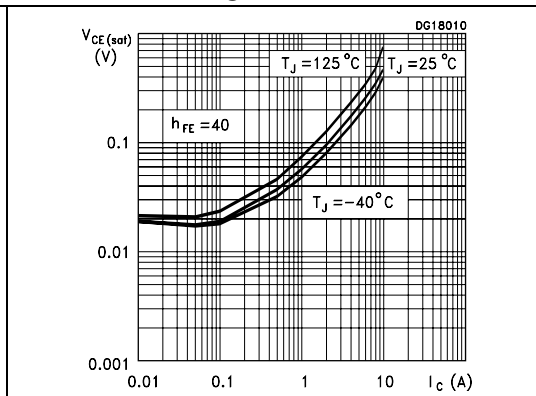


Figure 6. Base-emitter saturation voltage

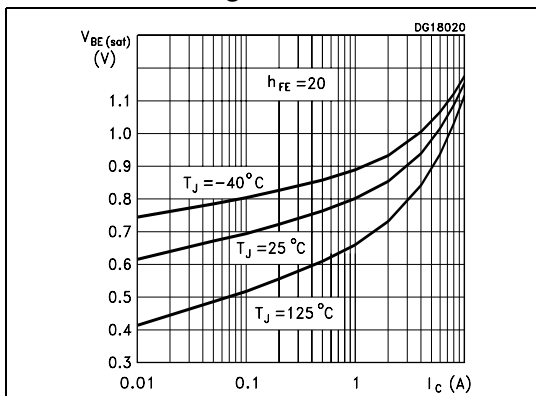
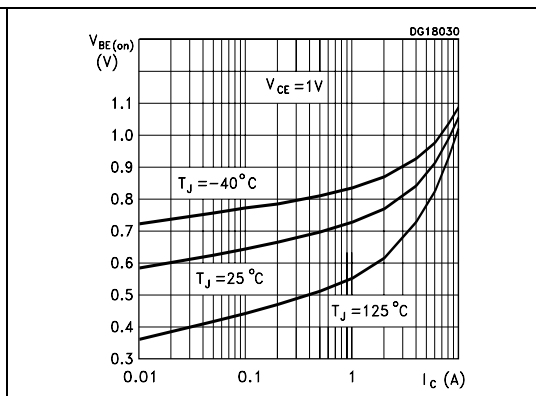
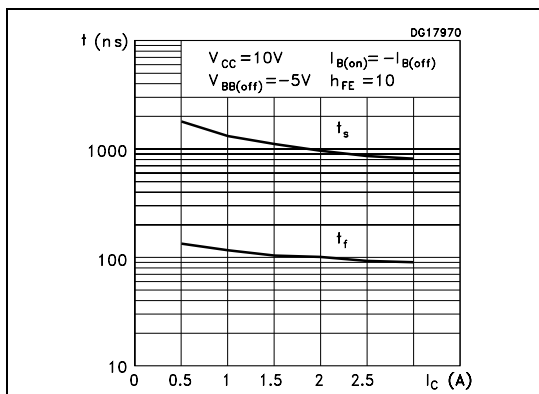


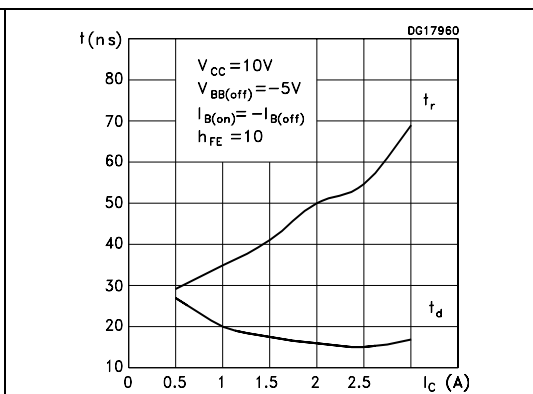
Figure 7. Base-emitter on voltage



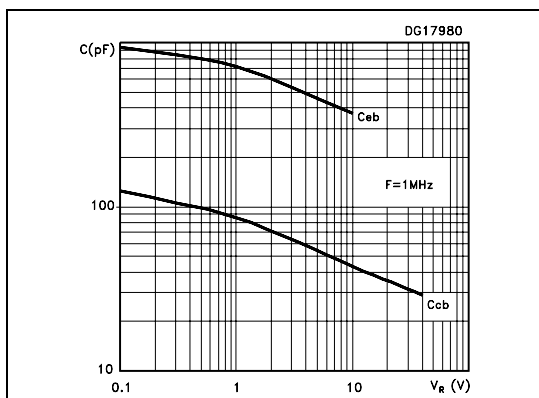
**Figure 8. Switching times resistive load**



**Figure 9. Switching times resistive load**

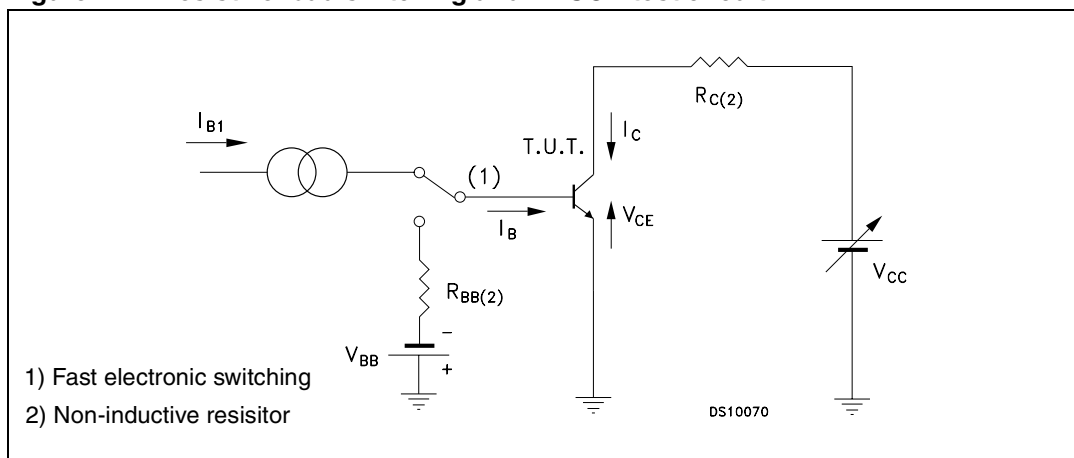


**Figure 10. Capacitance**



## 2.2 Test circuit

**Figure 11. Resistive load switching and RBSOA test circuit**

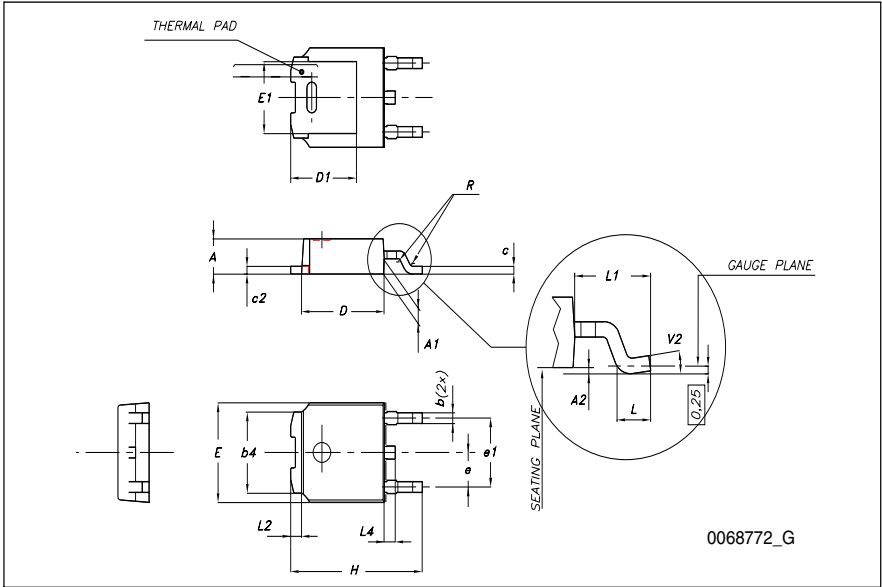


### 3 Package mechanical data

In order to meet environmental requirements, ST offers these devices in ECOPACK® packages. These packages have a Lead-free second level interconnect. The category of second level interconnect is marked on the package and on the inner box label, in compliance with JEDEC Standard JESD97. The maximum ratings related to soldering conditions are also marked on the inner box label. ECOPACK is an ST trademark. ECOPACK specifications are available at: [www.st.com](http://www.st.com)

**TO-252 (DPAK) mechanical data**

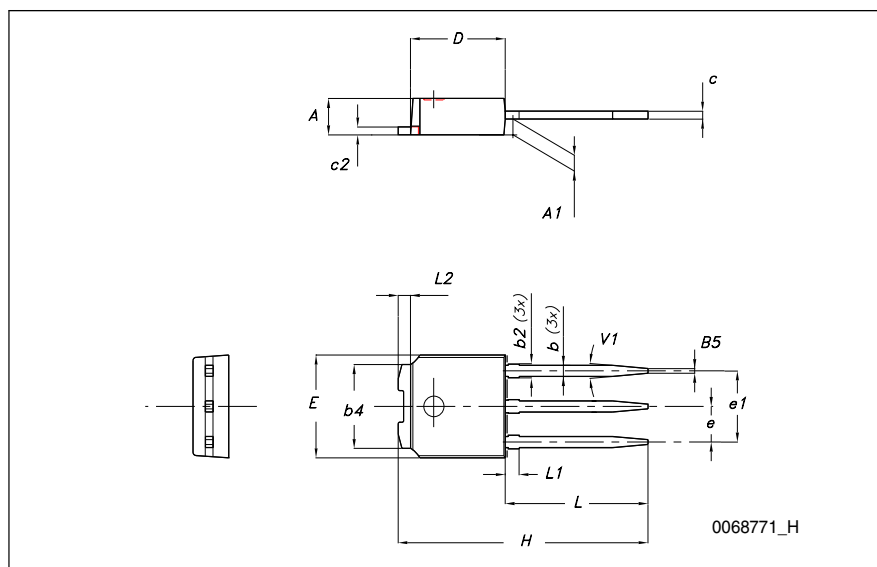
DIM.	mm.		
	min.	typ	max.
A	2.20		2.40
A1	0.90		1.10
A2	0.03		0.23
b	0.64		0.90
b4	5.20		5.40
c	0.45		0.60
c2	0.48		0.60
D	6.00		6.20
D1		5.10	
E	6.40		6.60
E1		4.70	
e		2.28	
e1	4.40		4.60
H	9.35		10.10
L	1		
L1		2.80	
L2		0.80	
L4	0.60		1
R		0.20	
V2	0°		8°





## TO-251 (IPAK) mechanical data

DIM.	mm.		
	min.	typ	max.
A	2.20		2.40
A1	0.90		1.10
b	0.64		0.90
b2			0.95
b4	5.20		5.40
B5		0.3	
c	0.45		0.60
c2	0.48		0.60
D	6.00		6.20
E	6.40		6.60
e		2.28	
e1	4.40		4.60
H		16.10	
L	9.00		9.40
L1	0.80		1.20
L2		0.80	1.00
V1		10°	



## 4 Revision history

**Table 5. Document revision history**

Date	Revision	Changes
08-May-2006	1	Initial release
27-Mar-2008	2	New graphics

**Please Read Carefully:**

Information in this document is provided solely in connection with ST products. STMicroelectronics NV and its subsidiaries ("ST") reserve the right to make changes, corrections, modifications or improvements, to this document, and the products and services described herein at any time, without notice.

All ST products are sold pursuant to ST's terms and conditions of sale.

Purchasers are solely responsible for the choice, selection and use of the ST products and services described herein, and ST assumes no liability whatsoever relating to the choice, selection or use of the ST products and services described herein.

No license, express or implied, by estoppel or otherwise, to any intellectual property rights is granted under this document. If any part of this document refers to any third party products or services it shall not be deemed a license grant by ST for the use of such third party products or services, or any intellectual property contained therein or considered as a warranty covering the use in any manner whatsoever of such third party products or services or any intellectual property contained therein.

**UNLESS OTHERWISE SET FORTH IN ST'S TERMS AND CONDITIONS OF SALE ST DISCLAIMS ANY EXPRESS OR IMPLIED WARRANTY WITH RESPECT TO THE USE AND/OR SALE OF ST PRODUCTS INCLUDING WITHOUT LIMITATION IMPLIED WARRANTIES OF MERCHANTABILITY, FITNESS FOR A PARTICULAR PURPOSE (AND THEIR EQUIVALENTS UNDER THE LAWS OF ANY JURISDICTION), OR INFRINGEMENT OF ANY PATENT, COPYRIGHT OR OTHER INTELLECTUAL PROPERTY RIGHT.**

**UNLESS EXPRESSLY APPROVED IN WRITING BY AN AUTHORIZED REPRESENTATIVE OF ST, ST PRODUCTS ARE NOT DESIGNED, AUTHORIZED OR WARRANTED FOR USE IN MILITARY, AIR CRAFT, SPACE, LIFE SAVING, OR LIFE SUSTAINING APPLICATIONS, NOR IN PRODUCTS OR SYSTEMS, WHERE FAILURE OR MALFUNCTION MAY RESULT IN PERSONAL INJURY, DEATH, OR SEVERE PROPERTY OR ENVIRONMENTAL DAMAGE.**

Resale of ST products with provisions different from the statements and/or technical features set forth in this document shall immediately void any warranty granted by ST for the ST product or service described herein and shall not create or extend in any manner whatsoever, any liability of ST.

ST and the ST logo are trademarks or registered trademarks of ST in various countries.

Information in this document supersedes and replaces all information previously supplied.

The ST logo is a registered trademark of STMicroelectronics. All other names are the property of their respective owners.

© 2008 STMicroelectronics - All rights reserved

STMicroelectronics group of companies

Australia - Belgium - Brazil - Canada - China - Czech Republic - Finland - France - Germany - Hong Kong - India - Israel - Italy - Japan - Malaysia - Malta - Morocco - Singapore - Spain - Sweden - Switzerland - United Kingdom - United States of America

[www.st.com](http://www.st.com)

